



Special Projects Group
(888) 284-4774

NOTES:

- 1) Verify that each component requiring or supplying power has been configured for proper system voltage before applying power.
- 2) All wires to be 18 awg 100' max unless otherwise noted on drawing. Refer to manufacturers instructions for proper wire gauge on any power supply, electric device or electrified lock hardware. Manufacturers requirements take precedence.
- 3) All line voltage power to be I/A/W local electrical code.
- 4) All low voltage wires to be stranded copper unless superseded by local electrical code or electric device manufacturer.
- 5) It is considered good electrical practice to run spare wires at any location that may be difficult to access after construction.

These drawings are the sole and exclusive property of Special Projects Group and contain sensitive privileged or confidential information which may be used only for its benefit. The disclosure of these drawings to unauthorized persons is strictly prohibited. This document and all copies must be returned upon demand.
COPYRIGHT © 2018 SPECIAL PROJECTS GROUP, INC.

FOR REFERENCE ONLY
This drawing is not a substitute for qualified field technicians.
One hour of telephone support is available without charge.

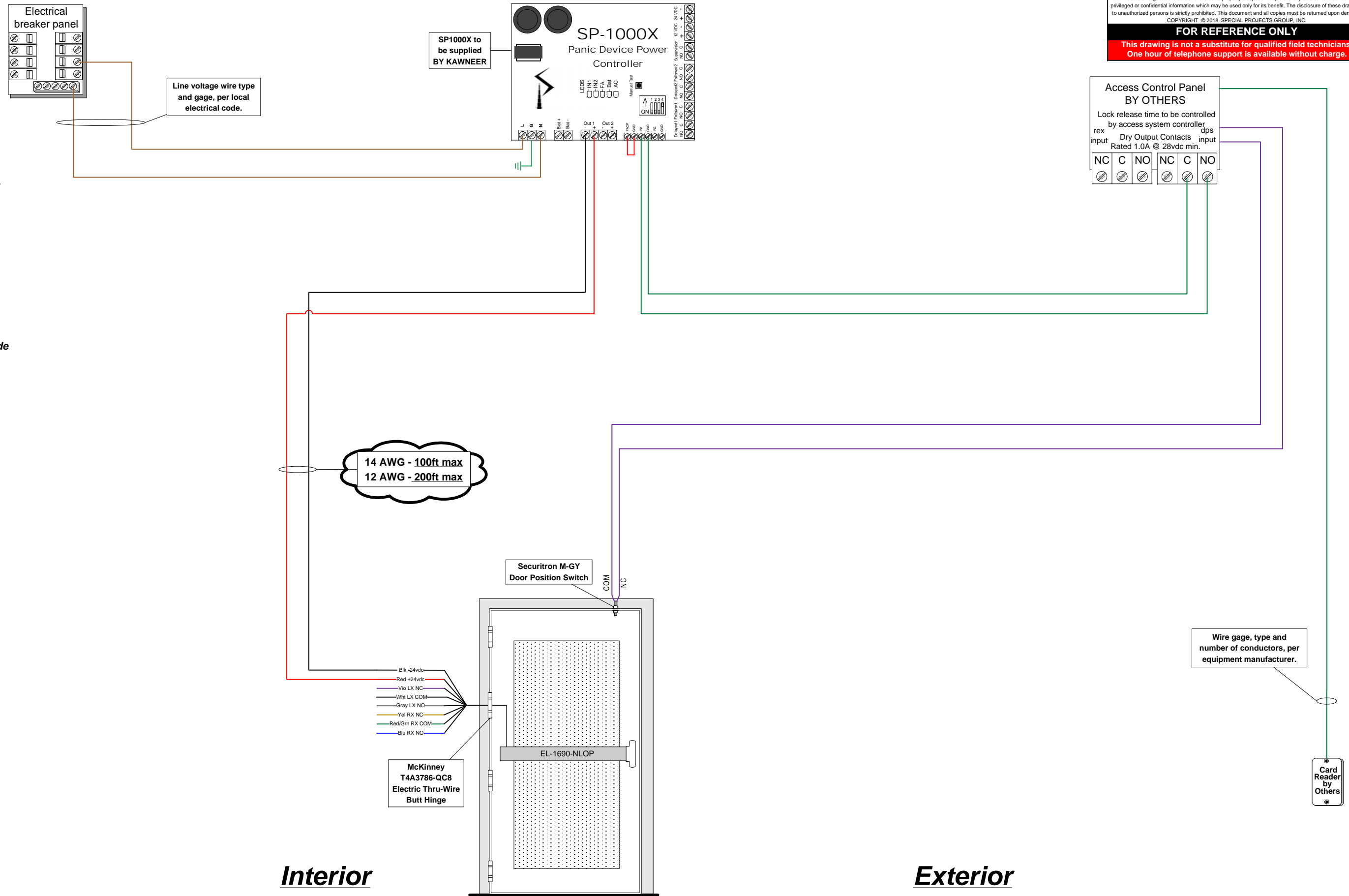

Electrical Circuit Legend	
Red	(+)VDC Power
Black	(-) VDC Power
Green	Signaling
Blue	Activation
Violet	Monitoring/Supervisory
Brown	AC High Voltage

Function Statement:

- From exterior - locked condition:** Access by presenting valid credential to retract exit device latchbolts electronically. Manual entry by key override via cylinder control.
- From exterior - unlocked condition:** Door to remain locked unless exit device latchbolts held retracted electronically by access system.
- From interior - locked condition:** Free egress at all times by means of exit device.
- From interior - unlocked condition:** Free egress at all times by means of exit device.
- General:**

Interior

Exterior

Title: SGL_etwbutt_RXEL1690_SP1000X.vsd	Project: 63-159706 OP / SO#3506101
HWSET: 9.0 / ARCH: 41.0	Door: 110B
Date: 1/18/2018	Date Printed: 1/18/2018
Drawn By: Cody Richardson	For: Kawneer Company
SO: 132930	Pg: 1 OF 2

NOTES:

- 1) Verify that each component requiring or supplying power has been configured for proper system voltage before applying power.
- 2) All wires to be 18 awg 100' max unless otherwise noted on drawing. Refer to manufacturers instructions for proper wire gauge on any power supply, electric device or electrified lock hardware. Manufacturers requirements take precedence.
- 3) All line voltage power to be I/A/W local electrical code.
- 4) All low voltage wires to be stranded copper unless superseded by local electrical code or electric device manufacturer.
- 5) It is considered good electrical practice to run spare wires at any location that may be difficult to access after construction.

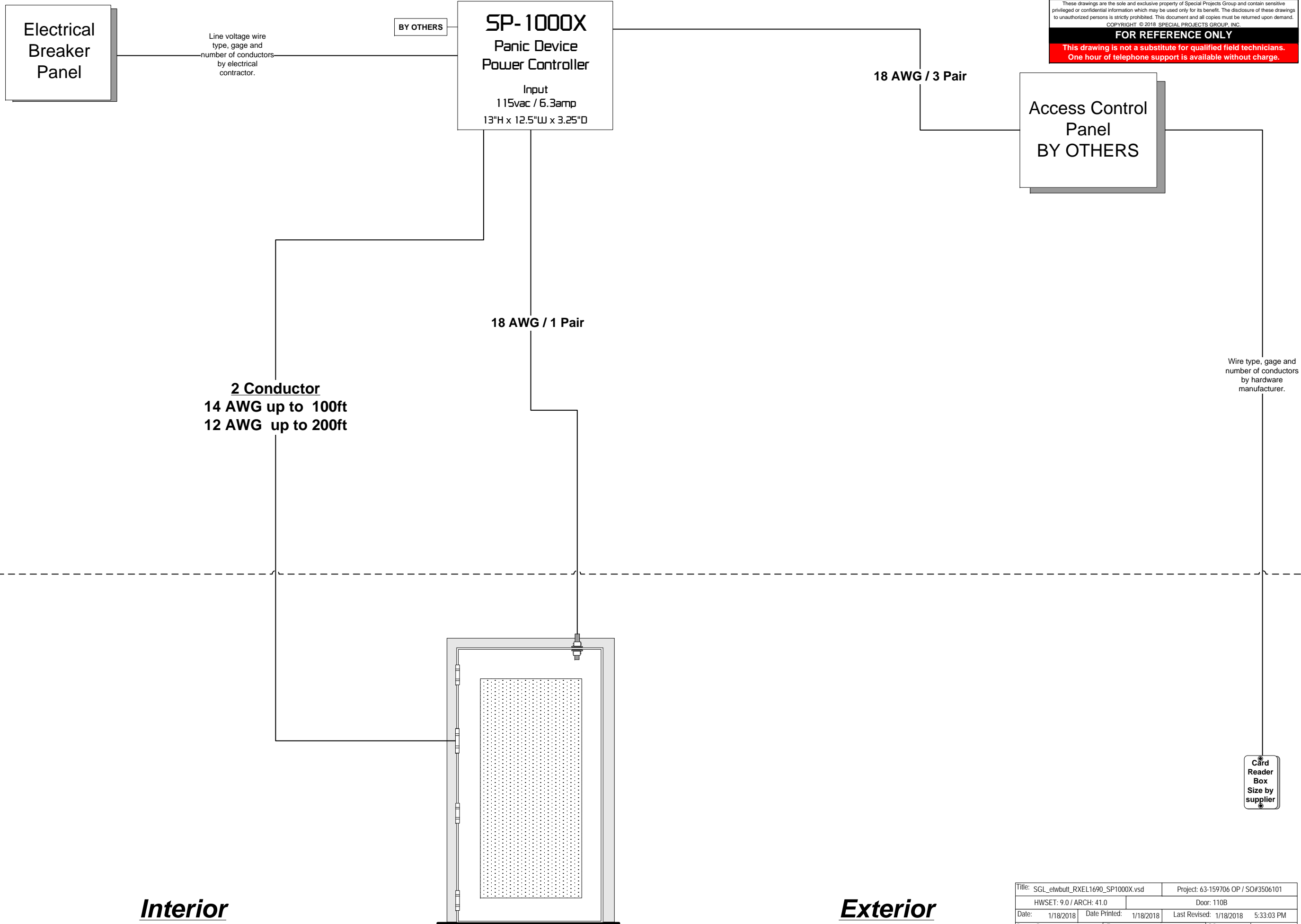

These drawings are the sole and exclusive property of Special Projects Group and contain sensitive privileged or confidential information which may be used only for its benefit. The disclosure of these drawings to unauthorized persons is strictly prohibited. This document and all copies must be returned upon demand. COPYRIGHT © 2018 SPECIAL PROJECTS GROUP, INC.

FOR REFERENCE ONLY
 This drawing is not a substitute for qualified field technicians.
 One hour of telephone support is available without charge.

Interior

Exterior

Title: SGL_etwbutt_RXEL1690_SP1000X.vsd		Project: 63-159706 OP / SO#3506101	
HWSET: 9.0 / ARCH: 41.0		Door: 110B	
Date: 1/18/2018	Date Printed: 1/18/2018	Last Revised: 1/18/2018	5:33:03 PM
Drawn By: Cody Richardson	For: Kawneer Company	SO: 132930	Pg: 2 OF 2

NOTES:

- 1) Verify that each component requiring or supplying power has been configured for proper system voltage before applying power.
- 2) All wires to be 18 awg 100' max unless otherwise noted on drawing. Refer to manufacturers instructions for proper wire gauge on any power supply, electric device or electrified lock hardware. Manufacturers requirements take precedence.
- 3) All line voltage power to be I/A/W local electrical code.
- 4) All low voltage wires to be stranded copper unless superseded by local electrical code or electric device manufacturer.
- 5) It is considered good electrical practice to run spare wires at any location that may be difficult to access after construction.

These drawings are the sole and exclusive property of Special Projects Group and contain sensitive privileged or confidential information which may be used only for its benefit. The disclosure of these drawings to unauthorized persons is strictly prohibited. This document and all copies must be returned upon demand.
COPYRIGHT © 2018 SPECIAL PROJECTS GROUP, INC.

FOR REFERENCE ONLY
This drawing is not a substitute for qualified field technicians.
One hour of telephone support is available without charge.

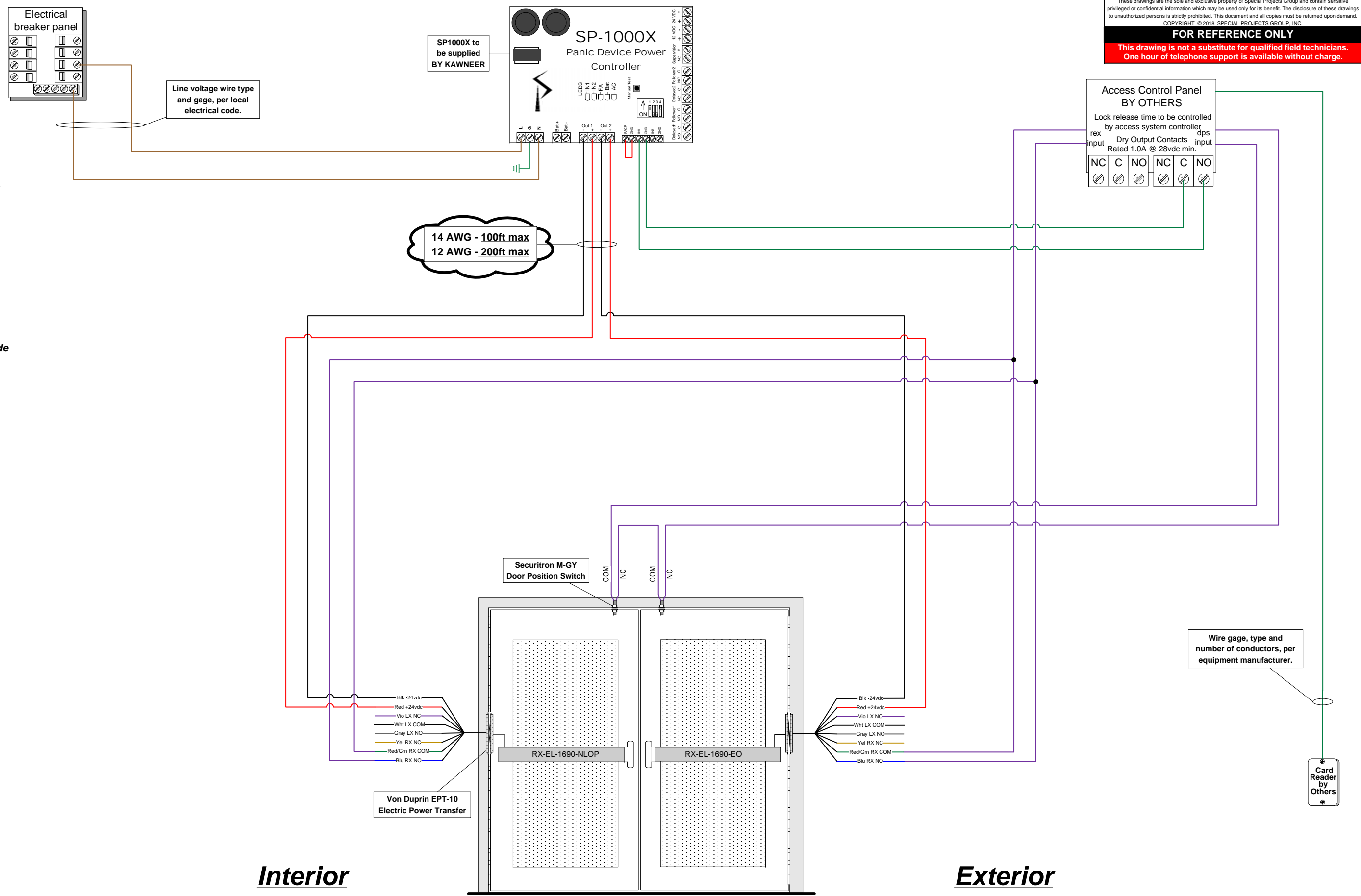

Electrical Circuit Legend

- Red = (+)VDC Power
- Black = (-) VDC Power
- Green = Signaling
- Blue = Activation
- Violet = Monitoring/Supervisory
- Brown = AC High Voltage

Function Statement:

- From exterior- locked condition:** Access by presenting valid credential to retract exit device latchbolts electronically. Manual entry by key override on active leaf via cylinder control.
- From exterior - unlocked condition:** Doors to remain locked unless exit device latchbolts held retracted electronically by access system.
- From interior - locked condition:** Free egress at all times by means of exit device. Request to exit signal sent to access system upon egress for forced door alarm event shunting.
- From interior - unlocked condition:** Free egress at all times by means of exit device. Request to exit signal sent to access system upon egress for forced door alarm event shunting.
- General:**

Interior

Exterior

Title: Pair_RXEL1690_SP1000X.vsd	Project: 63-159706 OP / SO#3506101
HWSET: 13.0 / ARCH: 60	Door: 2801CC
Date: 1/18/2018	Date Printed: 1/18/2018
Drawn By: Cody Richardson	For: Kawneer Company
SO: 132930	Pg: 1 OF 2

- NOTES:**
- 1) Verify that each component requiring or supplying power has been configured for proper system voltage before applying power.
 - 2) All wires to be 18 awg 100' max unless otherwise noted on drawing. Refer to manufacturers instructions for proper wire gauge on any power supply, electric device or electrified lock hardware. Manufacturers requirements take precedence.
 - 3) All line voltage power to be I/A/W local electrical code.
 - 4) All low voltage wires to be stranded copper unless superseded by local electrical code or electric device manufacturer.
 - 5) It is considered good electrical practice to run spare wires at any location that may be difficult to access after construction.

These drawings are the sole and exclusive property of Special Projects Group and contain sensitive privileged or confidential information which may be used only for its benefit. The disclosure of these drawings to unauthorized persons is strictly prohibited. This document and all copies must be returned upon demand.
COPYRIGHT © 2018 SPECIAL PROJECTS GROUP, INC.

FOR REFERENCE ONLY

This drawing is not a substitute for qualified field technicians. One hour of telephone support is available without charge.

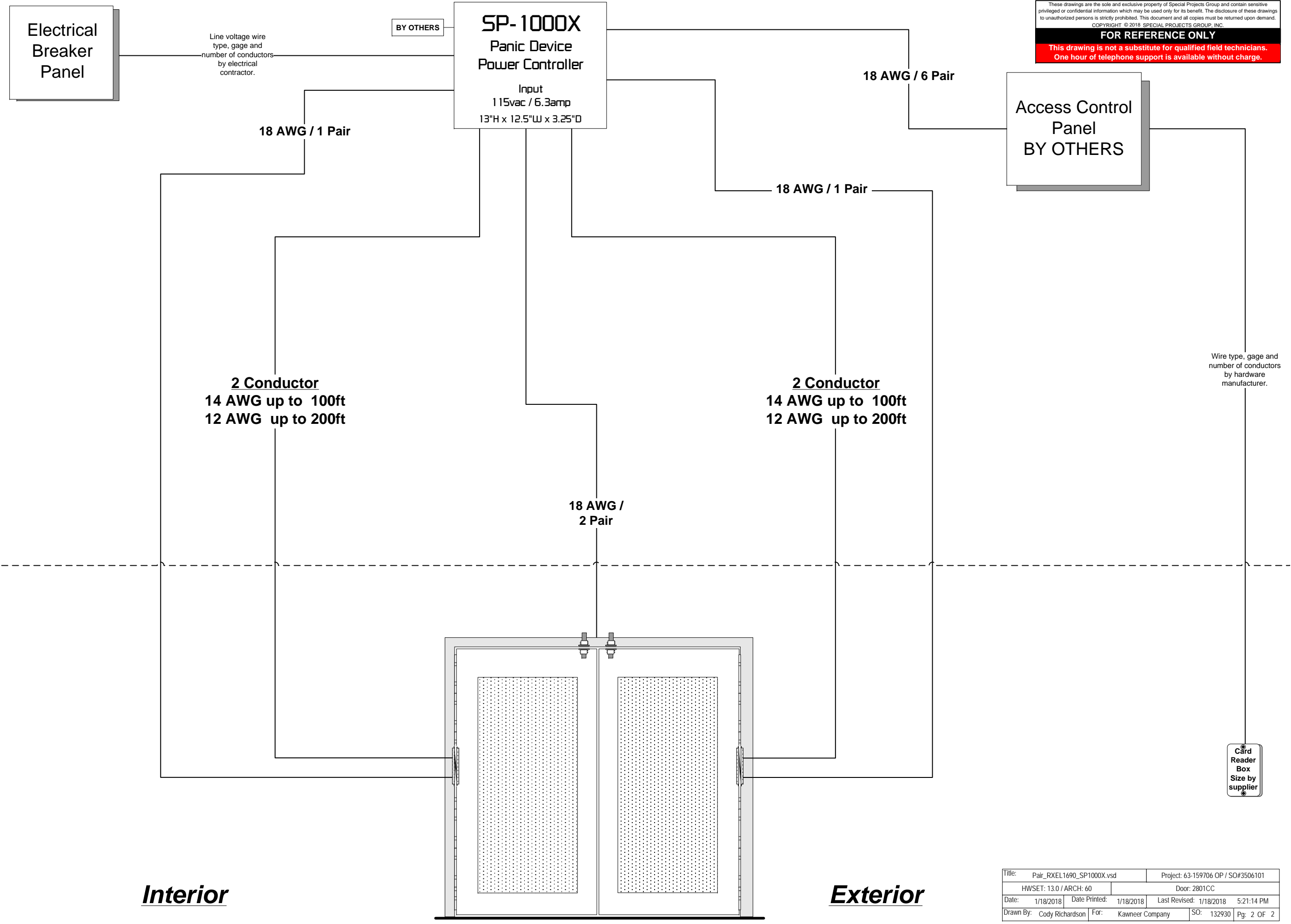

Title:	Pair_RXEL1690_SP1000X.vsd	Project:	63-159706 OP / SO#3506101
HWSET:	13.0 / ARCH: 60	Door:	2801CC
Date:	1/18/2018	Date Printed:	1/18/2018
		Last Revised:	1/18/2018
Drawn By:	Cody Richardson	For:	Kawneer Company
		SO:	132930
		Pg:	2 OF 2

NOTES:

- 1) Verify that each component requiring or supplying power has been configured for proper system voltage before applying power.
- 2) All wires to be 18 awg 100' max unless otherwise noted on drawing. Refer to manufacturers instructions for proper wire gauge on any power supply, electric device or electrified lock hardware. Manufacturers requirements take precedence.
- 3) All line voltage power to be I/A/W local electrical code.
- 4) All low voltage wires to be stranded copper unless superseded by local electrical code or electric device manufacturer.
- 5) It is considered good electrical practice to run spare wires at any location that may be difficult to access after construction.

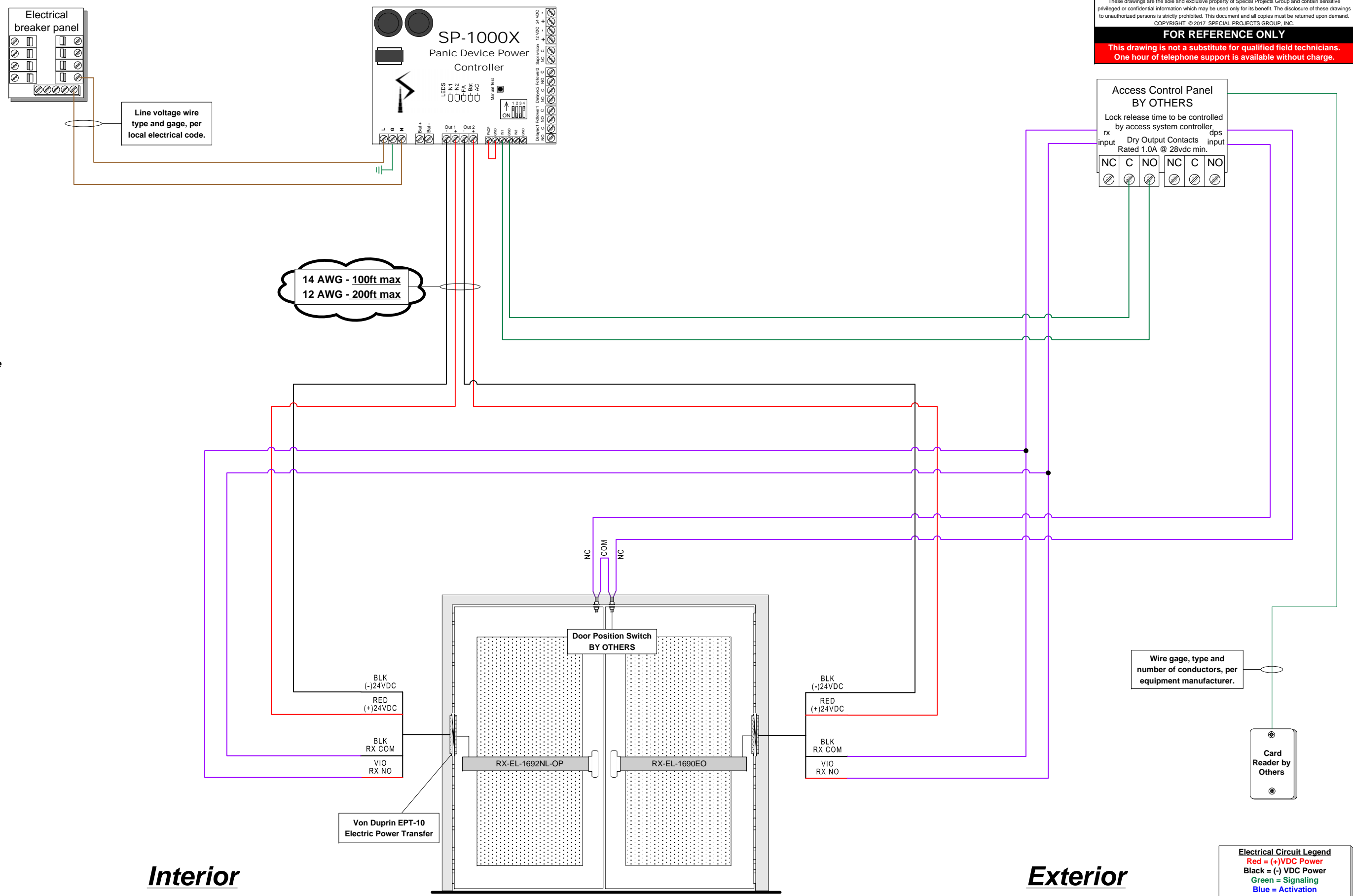

Interior

Exterior

Electrical Circuit Legend

- Red = (+)VDC Power
- Black = (-) VDC Power
- Green = Signaling
- Blue = Activation
- Violet = Monitoring/Supervisory
- Brown = AC High Voltage

Function Statement:

- From exterior- locked condition:** Access by presenting valid credential to retract electric exit device latchbolts. Manual entry by key on active leaf.
- From exterior - unlocked condition:** Doors to remain locked unless active electric exit device latchbolts held retracted by access system.
- From interior - locked condition:** Free egress at all times by means of exit device. RX signal sent to access system upon egress via exit device push pad for forced door alarm event (DPS) shunting.
- From interior - unlocked condition:** Free egress at all times by means of exit device. RX signal sent to access system upon egress via exit device push pad for forced door alarm event (DPS) shunting.

General:

Title: Pair_RX-EL-1690_SP1000X.vsd	Project: PO#62-159033op_SO#3497740
HWSET: 1.0/ARCH: 18	Door: 628B
Date: 12/11/2017	Date Printed: Last Revised: 12/11/2017 5:24:15 PM
Drawn By: Cody Richardson	For: Kawneer Company SO: 132477 Pg: 1 OF 2

NOTES:

- 1) Verify that each component requiring or supplying power has been configured for proper system voltage before applying power.
- 2) All wires to be 18 awg 100' max unless otherwise noted on drawing. Refer to manufacturers instructions for proper wire gauge on any power supply, electric device or electrified lock hardware. Manufacturers requirements take precedence.
- 3) All line voltage power to be I/A/W local electrical code.
- 4) All low voltage wires to be stranded copper unless superseded by local electrical code or electric device manufacturer.
- 5) It is considered good electrical practice to run spare wires at any location that may be difficult to access after construction.

These drawings are the sole and exclusive property of Special Projects Group and contain sensitive privileged or confidential information which may be used only for its benefit. The disclosure of these drawings to unauthorized persons is strictly prohibited. This document and all copies must be returned upon demand.
COPYRIGHT © 2017 SPECIAL PROJECTS GROUP, INC.
FOR REFERENCE ONLY
This drawing is not a substitute for qualified field technicians.
One hour of telephone support is available without charge.

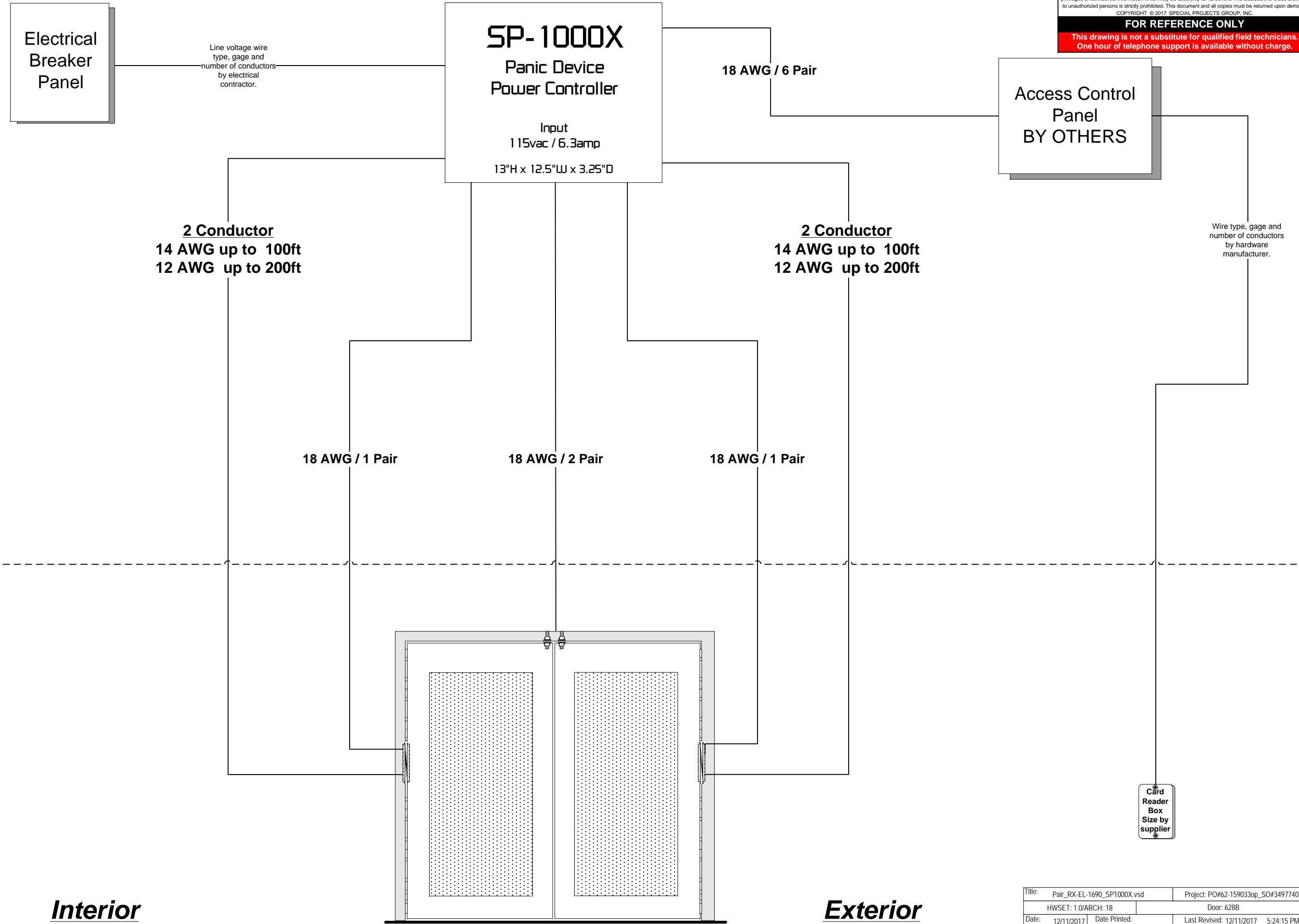

Interior

Exterior

Title: Pair_RX-EL-1690_SP1000X.vsd	Project: PO#62-159033op_SO#3497740
HWSET: 1.0/ARCH: 18	Door: 628B
Date: 12/11/2017	Date Printed: 12/11/2017 5:24:15 PM
Drawn By: Cody Richardson	For: Kawneer Company SO: 132477 Pg: 2 OF 2

NOTES:

- 1) Verify that each component requiring or supplying power has been configured for proper system voltage before applying power.
- 2) All wires to be 18 awg 100' max unless otherwise noted on drawing. Refer to manufacturers instructions for proper wire gauge on any power supply, electric device or electrified lock hardware. Manufacturers requirements take precedence.
- 3) All line voltage power to be I/A/W local electrical code.
- 4) All low voltage wires to be stranded copper unless superseded by local electrical code or electric device manufacturer.

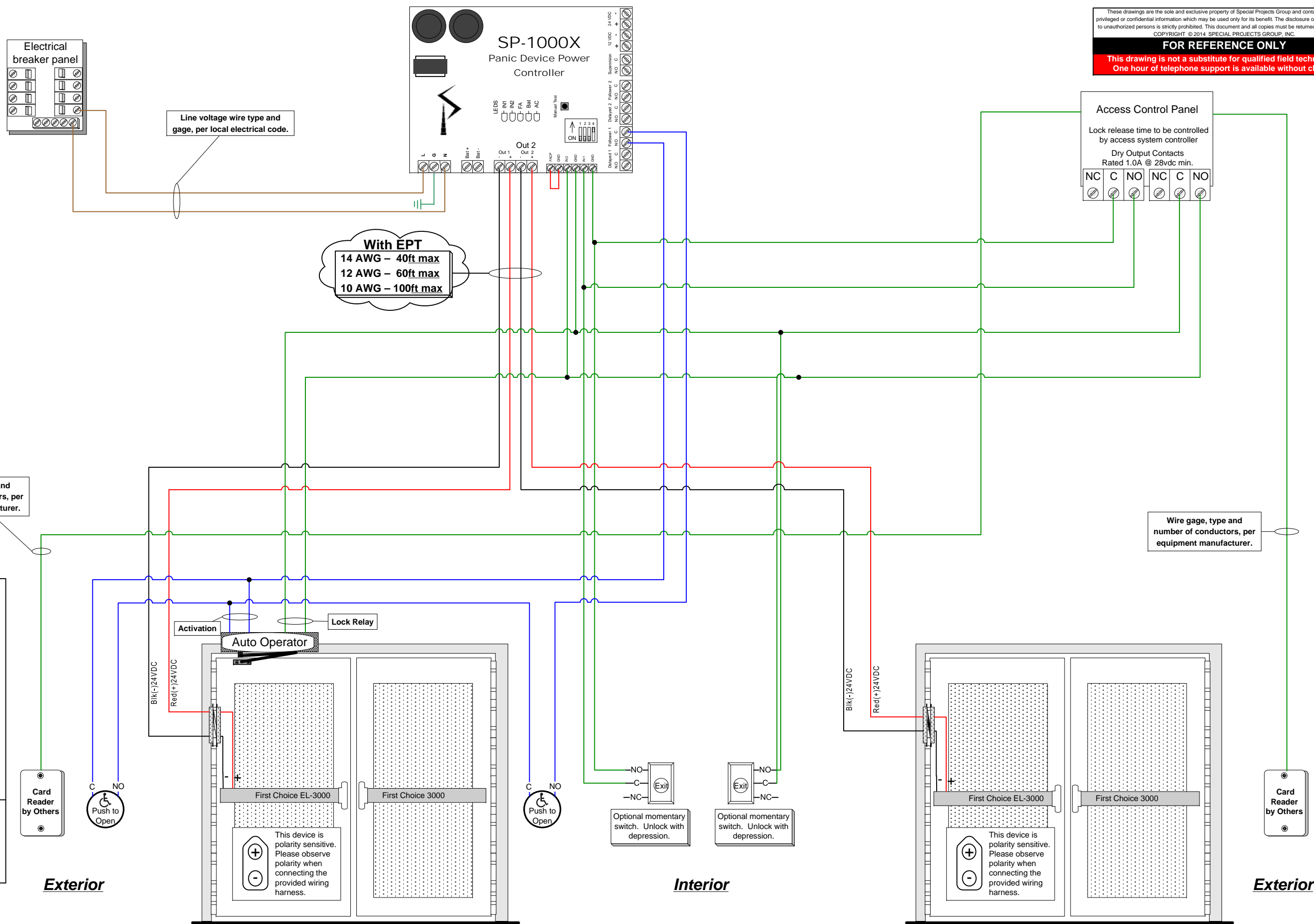

POWER TRANSFERS

NOTE:
Optional power transfers are available. Please note variations in wire size and maximum run length for these options.

14 AWG - 35 ft max
12 AWG - 55 ft max
10 AWG - 95 ft max

NOTE:
Make certain to maintain consistent wire color across the transfer to maintain polarity.

Function Statement:

- From exterior - locked condition:** Access by presenting valid credential at reader interface to retract active leaf electric exit device latch and enable exterior actuator use.
- From exterior - unlocked condition:** Doors to remain locked unless electric exit device latch held retracted by access system or momentarily unlocked by push button.
- From interior - locked condition:** Free egress at all times by means of exit device or by pressing interior handicap actuator to unlock and swing door.
- From interior - unlocked condition:** Free egress at all times by means of exit device or by pressing interior handicap actuator to unlock and swing door.
- General:** This is a basic/generic sample diagram for reference only. For project specific wiring diagrams, please contact Special Projects Group.

Title: First Choice EL Device 2 Pair Active SP-1000X AOB0.vsd		Project: Sample Diagram	
HWSET: 1A		Door: Example A/B	
Date: 9/14/2017	Date Printed:	Last Revised: 9/14/2017	11:58:41 AM
Drawn By: Cody Richardson	For: First Choice Building Products	SO:	1 OF 1



Special Projects Group
(888) 284-4774

NOTES:

- 1) Verify that each component requiring or supplying power has been configured for proper system voltage before applying power.
- 2) All wires to be 18 awg 100' max unless otherwise noted on drawing. Refer to manufacturers instructions for proper wire gauge on any power supply, electric device or electrified lock hardware. Manufacturers requirements take precedence.
- 3) All line voltage power to be I/A/W local electrical code.
- 4) All low voltage wires to be stranded copper unless superseded by local electrical code or electric device manufacturer.

POWER TRANSFERS

NOTE:

Optional power transfers are available. Please note variations in wire size and maximum run length for these options.

- 14 AWG - 35 ft max
- 12 AWG - 55 ft max
- 10 AWG - 95 ft max

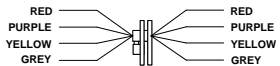
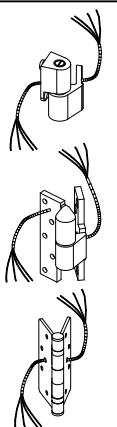

NOTE: Make certain to maintain consistent wire color across the transfer to maintain polarity.

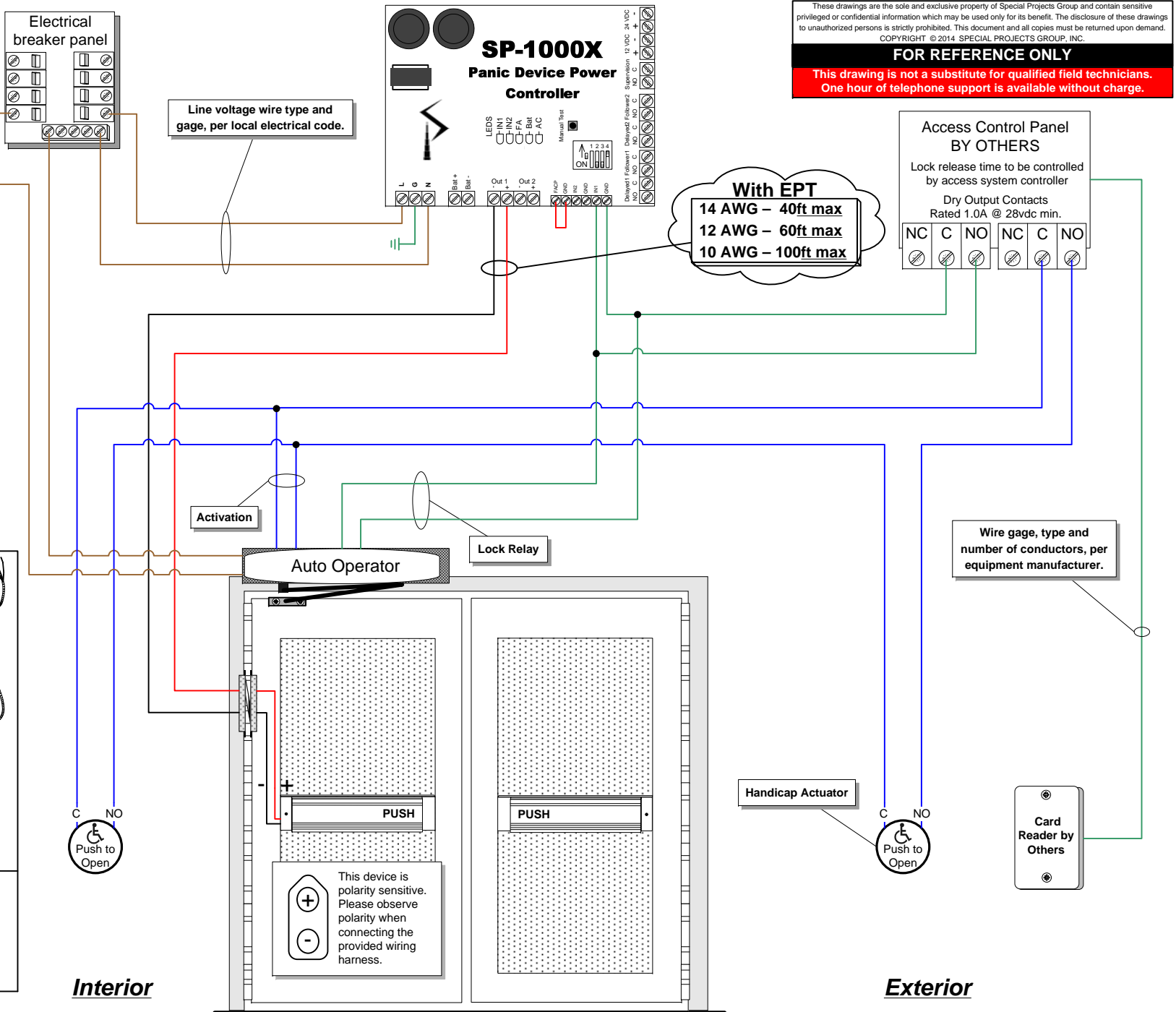

These drawings are the sole and exclusive property of Special Projects Group and contain sensitive privileged or confidential information which may be used only for its benefit. The disclosure of these drawings to unauthorized persons is strictly prohibited. This document and all copies must be returned upon demand. COPYRIGHT © 2014. SPECIAL PROJECTS GROUP, INC.

FOR REFERENCE ONLY

This drawing is not a substitute for qualified field technicians. One hour of telephone support is available without charge.

Function Statement:

- From exterior - locked condition:** Access by presenting valid card to unlock active leaf and make exterior actuator available to swing active leaf.
- From exterior - unlocked condition:** Doors to remain locked unless active leaf held unlocked by access system. Press actuator to swing active leaf.
- From interior - locked condition:** Free egress by means of exit device. Interior actuator always available to swing door.
- From interior - unlocked condition:** Free egress by means of exit device. Interior actuator always available to swing door.
- General:** This is a basic generic wiring diagram. For a project specific wiring diagram contact your Kawneer representative.

Title: Paneline EL 1 Active w Operator SP-1000X.vsd		Project: Paneline EL 1 Active w Operator	
Heading: Paneline EL		Door: Kawneer Paneline	
Date: 3/19/2014	Date Printed: 2/19/2014	Last Revised: 2/19/2014	4:09:35 PM
Drawn By: Cody Richardson	For: Kawneer Company, Inc.		Pg: 1 OF 1



Special Projects Group
(888) 284-4774

NOTES:

- 1) Verify that each component requiring or supplying power has been configured for proper system voltage before applying power.
- 2) All wires to be 18 awg 100' max unless otherwise noted on drawing. Refer to manufacturers instructions for proper wire gauge on any power supply, electric device or electrified lock hardware. Manufacturers requirements take precedence.
- 3) All line voltage power to be I/A/W local electrical code.
- 4) All low voltage wires to be stranded copper unless superseded by local electrical code or electric device manufacturer.

POWER TRANSFERS

NOTE:

Optional power transfers are available. Please note variations in wire size and maximum run length for these options.

- 14 AWG - 35 ft max
- 12 AWG - 55 ft max
- 10 AWG - 95 ft max

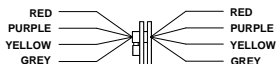
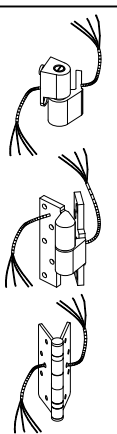

NOTE: Make certain to maintain consistent wire color across the transfer to maintain polarity.

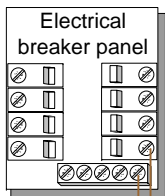

Line voltage wire type and gage, per local electrical code.

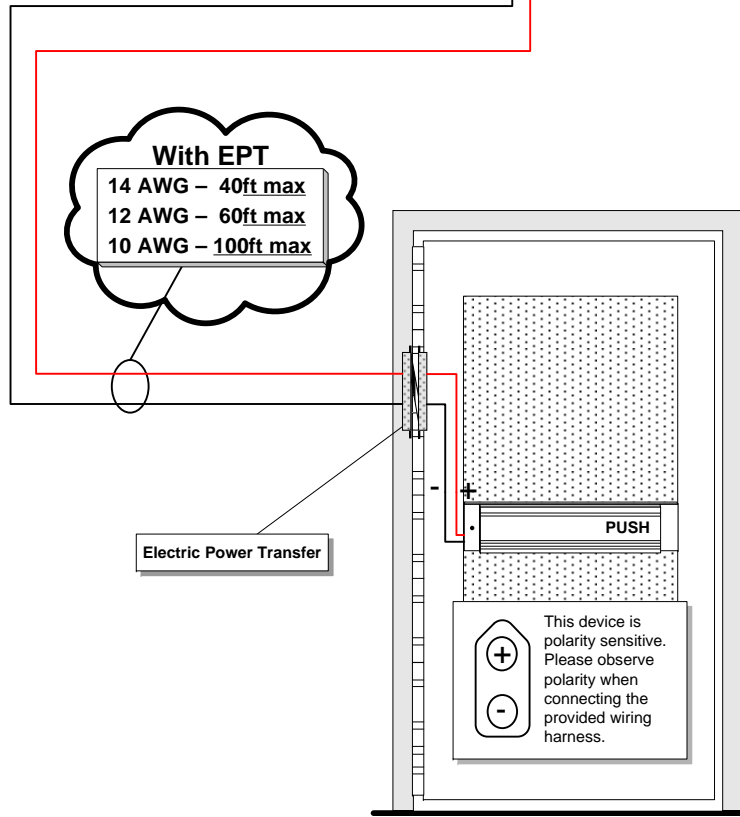
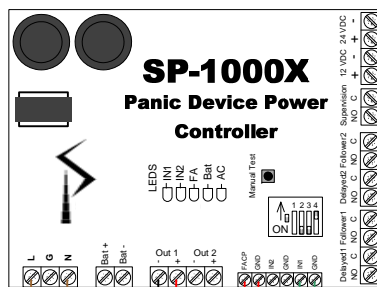

With EPT
14 AWG – 40ft max
12 AWG – 60ft max
10 AWG – 100ft max

Electric Power Transfer

This device is polarity sensitive. Please observe polarity when connecting the provided wiring harness.

These drawings are the sole and exclusive property of Special Projects Group and contain sensitive privileged or confidential information which may be used only for its benefit. The disclosure of these drawings to unauthorized persons is strictly prohibited. This document and all copies must be returned upon demand. COPYRIGHT © 2014. SPECIAL PROJECTS GROUP, INC.

FOR REFERENCE ONLY

This drawing is not a substitute for qualified field technicians. One hour of telephone support is available without charge.

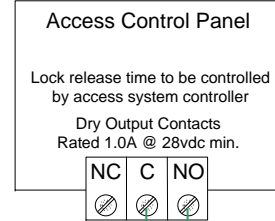

Wire gage, type and number of conductors, per equipment manufacturer.

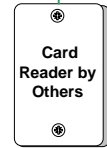
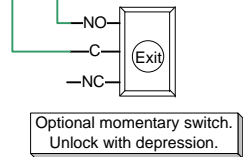

Function Statement:

- From exterior- locked condition:** Access by presenting valid credential to unlock door.
- From exterior - unlocked condition:** Doors to remain locked unless held unlocked by access control system.
- From interior - locked condition:** Free egress at all times by means of exit device.
- From interior - unlocked condition:** Free egress at all times by means of exit device.
- General:** This is a basic generic wiring diagram. For a project specific wiring diagram contact your Kawneer representative.

Title: Paneline EL Exit Device 1 Single-SP-1000X.vsd		Project: Paneline EL 1 single door	
Heading: Paneline EL		Door: Kawneer Paneline	
Date: 5/5/2014	Date Printed: 5/5/2014	Last Revised: 01/22/2014	5:14:26 PM
Drawn By: Cody Richardson	For: Kawneer Company, Inc.		Pg: 1 Of 1



Special Projects Group
(888) 284-4774

NOTES:

- 1) Verify that each component requiring or supplying power has been configured for proper system voltage before applying power.
- 2) All wires to be 18 awg 100' max unless otherwise noted on drawing. Refer to manufacturers instructions for proper wire gauge on any power supply, electric device or electrified lock hardware. Manufacturers requirements take precedence.
- 3) All line voltage power to be I/A/W local electrical code.
- 4) All low voltage wires to be stranded copper unless superseded by local electrical code or electric device manufacturer.

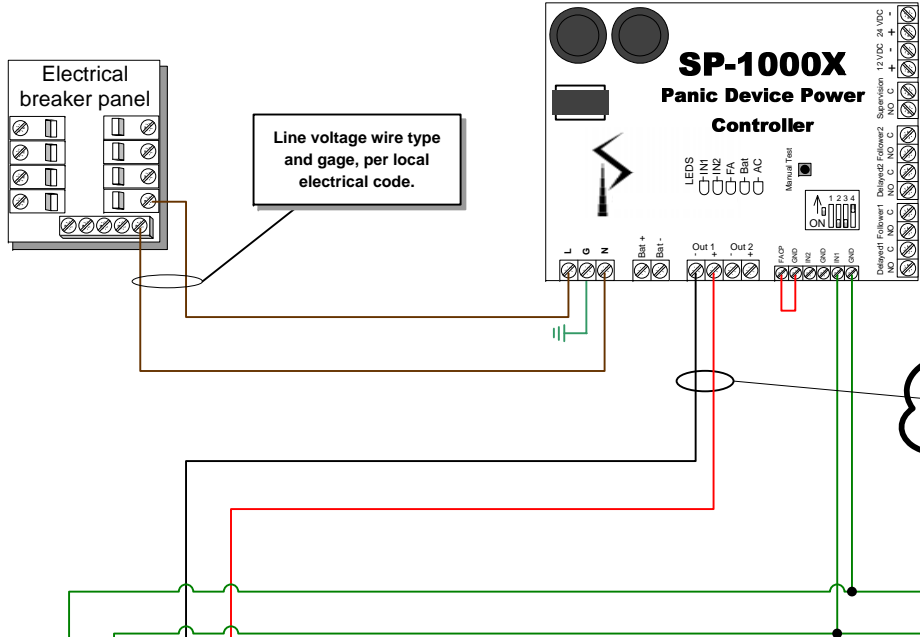

Line voltage wire type and gage, per local electrical code.

14 AWG - 40ft max
12 AWG - 60ft max
10 AWG - 100ft max

These drawings are the sole and exclusive property of Special Projects Group and contain sensitive privileged or confidential information which may be used only for its benefit. The disclosure of these drawings to unauthorized persons is strictly prohibited. This document and all copies must be returned upon demand.
COPYRIGHT © 2014. SPECIAL PROJECTS GROUP, INC.
FOR REFERENCE ONLY
This drawing is not a substitute for qualified field technicians.
One hour of telephone support is available without charge.

POWER TRANSFERS

NOTE:

Optional power transfers are available. Please note variations in wire size and maximum run length for these options.

14 AWG - 35 ft max
12 AWG - 55 ft max
10 AWG - 95 ft max

RED PURPLE YELLOW GREY

RED PURPLE YELLOW GREY

NOTE:
Make certain to maintain consistent wire color across the transfer to maintain polarity.

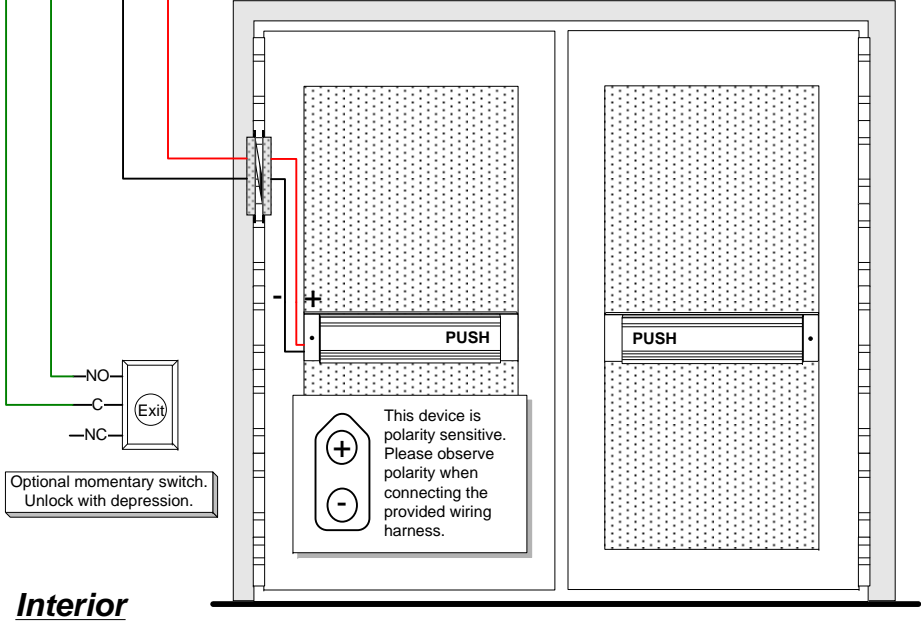

Interior

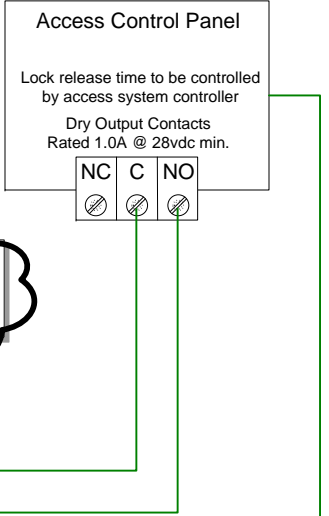

Wire gage, type and number of conductors, per equipment manufacturer.

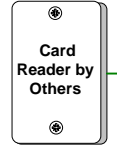

Exterior

Function Statement:

- From exterior - locked condition:** Access by presenting valid credential to unlock active leaf.
- From exterior - unlocked condition:** Doors to remain locked unless held unlocked by access control system.
- From interior - locked condition:** Free egress at all times by means of exit device.
- From interior - unlocked condition:** Free egress at all times by means of exit device.
- General:** This is a basic generic wiring diagram. For a project specific wiring diagram contact your Kawneer representative.

Title: Paneline EL Exit Device 1 Pair 1 Active SP1000X.vsd	Project: Paneline EL 1 Pair with 1 Active		
Heading: Paneline EL	Door: Kawneer Paneline		
Date: 5/5/2014	Date Printed: 01/20/2014	Last Revised: 5/5/2014	5:17:29 PM
Drawn By: Cody Richardson	For: Kawneer Company, Inc.	Pg: 1	OF 1



Special Projects Group
(888) 284-4774

NOTES:

- 1) Verify that each component requiring or supplying power has been configured for proper system voltage before applying power.
- 2) All wires to be 18 awg 100' max unless otherwise noted on drawing. Refer to manufacturers instructions for proper wire gauge on any power supply, electric device or electrified lock hardware. Manufacturers requirements take precedence.
- 3) All line voltage power to be I/A/W local electrical code.
- 4) All low voltage wires to be stranded copper unless superseded by local electrical code or electric device manufacturer.

POWER TRANSFERS

NOTE:

Optional power transfers are available. Please note variations in wire size and maximum run length for these options.

- 14 AWG - 35 ft max
- 12 AWG - 55 ft max
- 10 AWG - 95 ft max

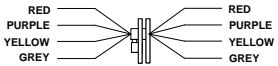
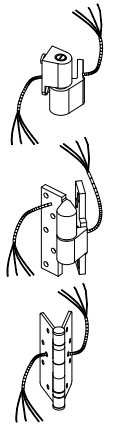

NOTE: Make certain to maintain consistent wire color across the transfer to maintain polarity.

Function Statement:

- From exterior - locked condition:** Access by presenting valid credential to unlock doors.
- From exterior - unlocked condition:** Doors to remain locked unless held unlocked by access control system.
- From interior - locked condition:** Free egress at all times by means of exit device.
- From interior - unlocked condition:** Free egress at all times by means of exit device.
- General:** This is a basic generic wiring diagram. For a project specific wiring diagram contact your Kawneer representative.

These drawings are the sole and exclusive property of Special Projects Group and contain sensitive privileged or confidential information which may be used only for its benefit. The disclosure of these drawings to unauthorized persons is strictly prohibited. This document and all copies must be returned upon demand.
COPYRIGHT © 2014. SPECIAL PROJECTS GROUP, INC.

FOR REFERENCE ONLY

This drawing is not a substitute for qualified field technicians. One hour of telephone support is available without charge.

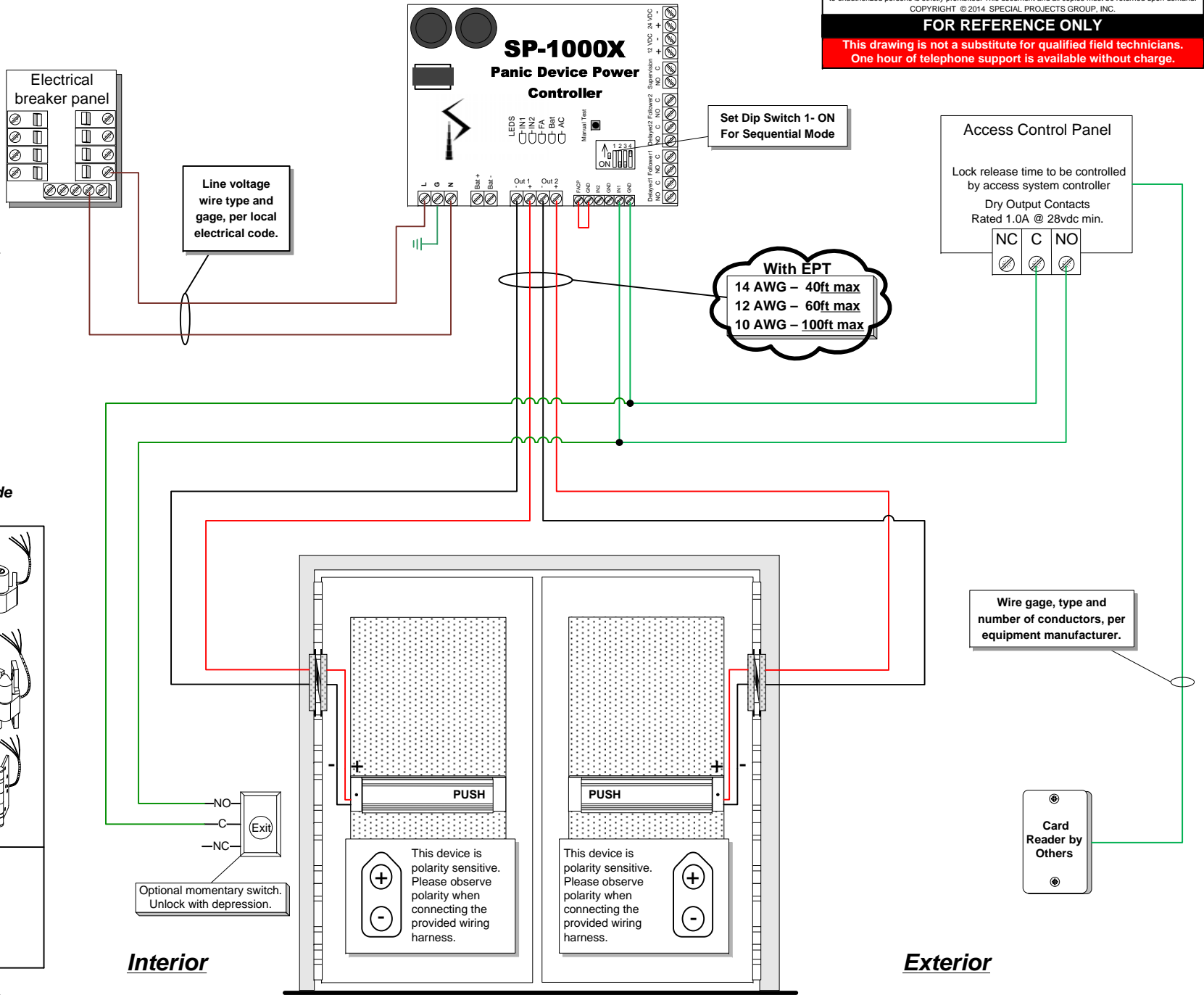

Title: Paneline EL Exit Device 1 Pair 2 Active SP1000X.vsd	Project: Paneline EL 1 Pair with 2 Active
Heading: Paneline EL	Door: Kawneer Paneline
Date: 5/5/2014	Date Printed: 01/20/2014
Drawn By: Cody Richardson	Last Revised: 01/20/2014 5:18:41 PM
For: Kanweer Company Inc.	Pg: 1 OF 1



Special Projects Group
(888) 284-4774

NOTES:

- 1) Verify that each component requiring or supplying power has been configured for proper system voltage before applying power.
- 2) All wires to be 18 awg 100' max unless otherwise noted on drawing. Refer to manufacturers instructions for proper wire gauge on any power supply, electric device or electrified lock hardware. Manufacturers requirements take precedence.
- 3) All line voltage power to be I/A/W local electrical code.
- 4) All low voltage wires to be stranded copper unless superseded by local electrical code or electric device manufacturer.

POWER TRANSFERS

NOTE:

Optional power transfers are available. Please note variations in wire size and maximum run length for these options.

- 14 AWG - 35 ft max
- 12 AWG - 55 ft max
- 10 AWG - 95 ft max

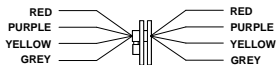
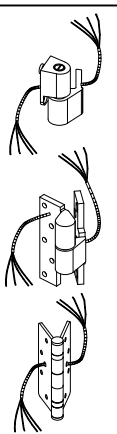

NOTE: Make certain to maintain consistent wire color across the transfer to maintain polarity.

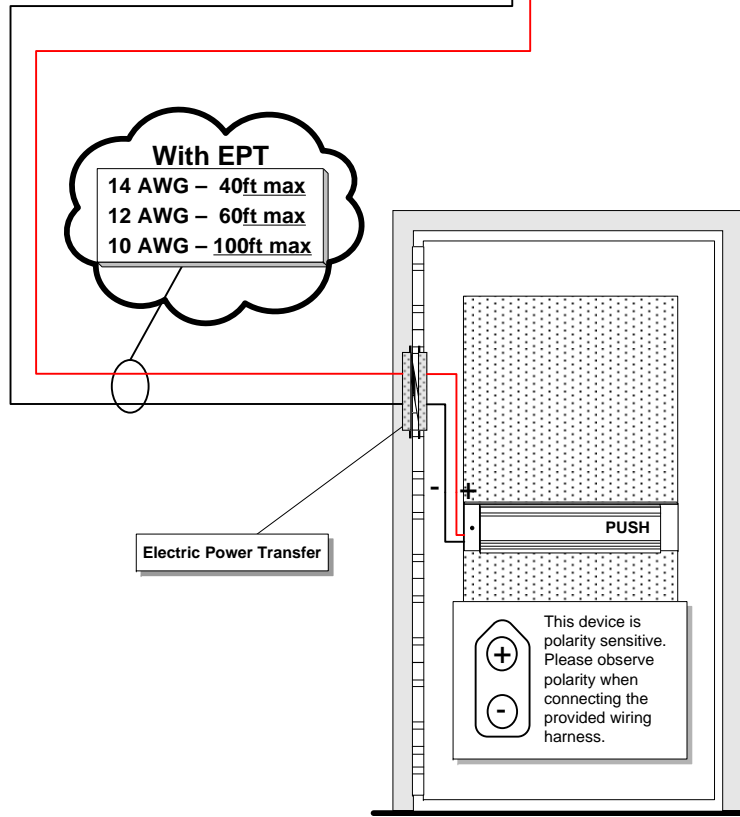
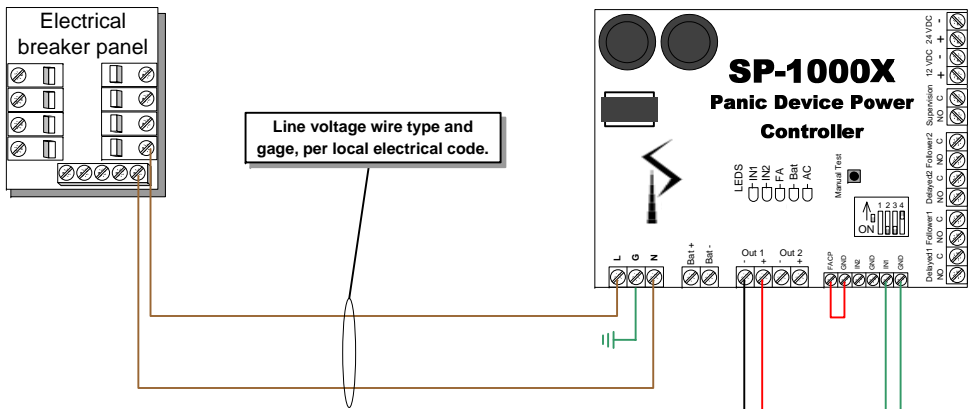

These drawings are the sole and exclusive property of Special Projects Group and contain sensitive privileged or confidential information which may be used only for its benefit. The disclosure of these drawings to unauthorized persons is strictly prohibited. This document and all copies must be returned upon demand. COPYRIGHT © 2014. SPECIAL PROJECTS GROUP, INC.

FOR REFERENCE ONLY

This drawing is not a substitute for qualified field technicians. One hour of telephone support is available without charge.

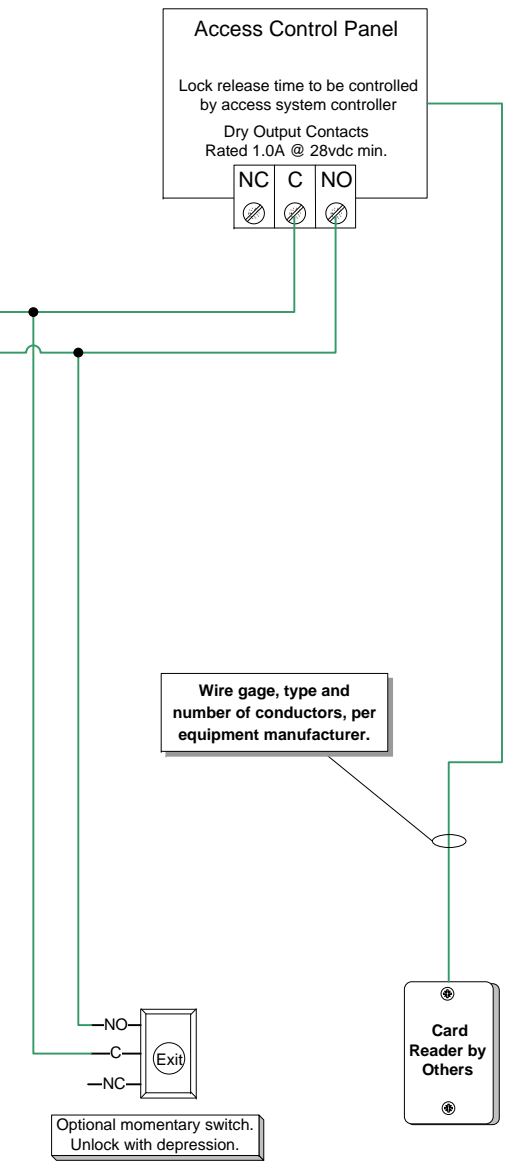

Function Statement:

- From exterior- locked condition:** Access by presenting valid credential to unlock door.
- From exterior - unlocked condition:** Doors to remain locked unless held unlocked by access control system.
- From interior - locked condition:** Free egress at all times by means of exit device.
- From interior - unlocked condition:** Free egress at all times by means of exit device.
- General:** This is a basic generic wiring diagram. For a project specific wiring diagram contact your Kawneer representative.

Title: Paneline EL Exit Device 1 Single-SP-1000X.vsd		Project: Paneline EL 1 single door	
Heading: Paneline EL		Door: Kawneer Paneline	
Date: 5/5/2014	Date Printed: 5/5/2014	Last Revised: 01/22/2014	5:14:26 PM
Drawn By: Cody Richardson	For: Kawneer Company, Inc.		Pg: 1 Of 1

NOTES:

- 1) Verify that each component requiring or supplying power has been configured for proper system voltage before applying power.
- 2) All wires to be 18 awg 100' max unless otherwise noted on drawing. Refer to manufacturers instructions for proper wire gauge on any power supply, electric device or electrified lock hardware. Manufacturers requirements take precedence.
- 3) All line voltage power to be I/A/W local electrical code.
- 4) All low voltage wires to be stranded copper unless superseded by local electrical code or electric device manufacturer.

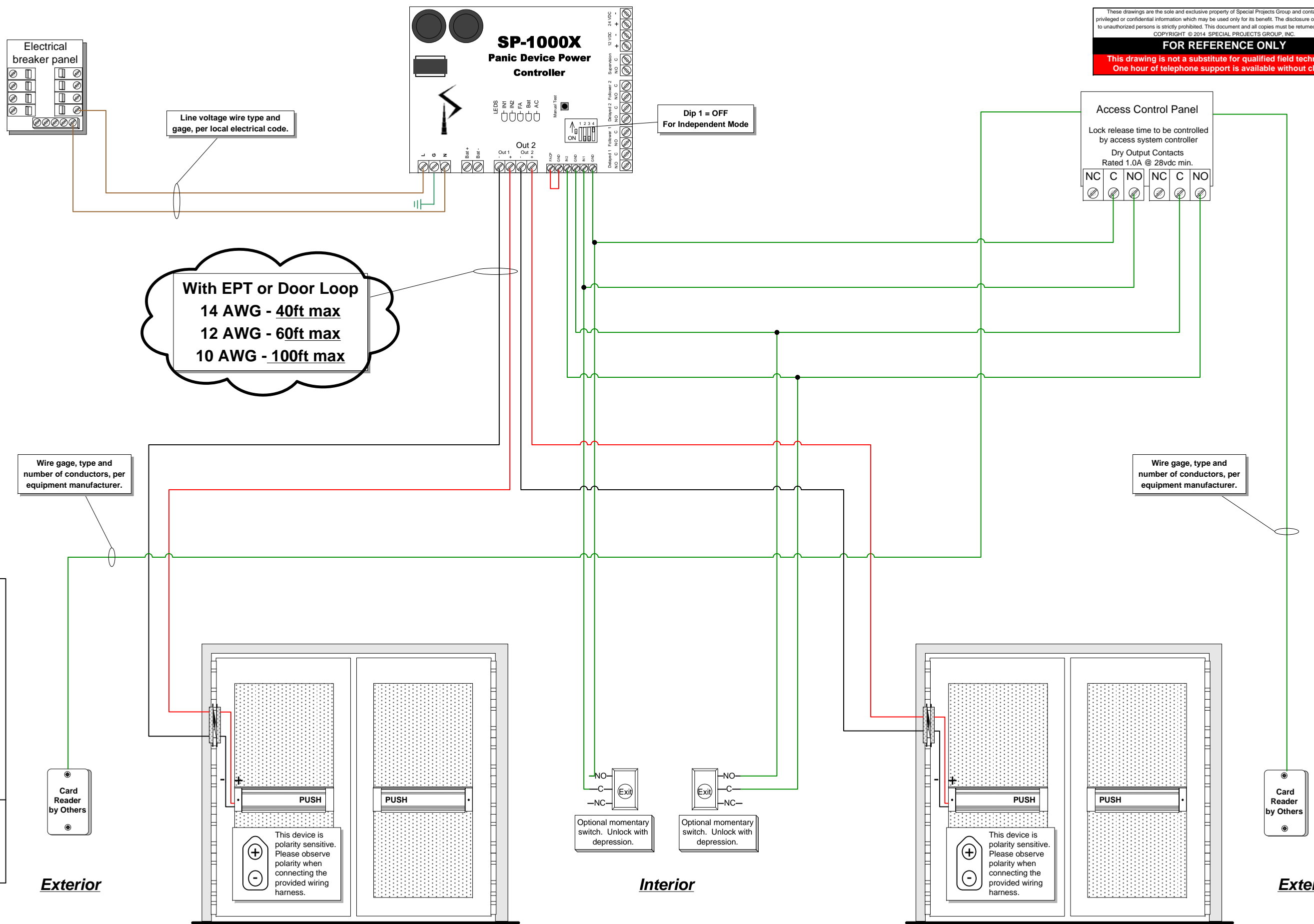

POWER TRANSFERS

NOTE:
Optional power transfers are available. Please note variations in wire size and maximum run length for these options.

14 AWG - 35 ft max
12 AWG - 55 ft max
10 AWG - 95 ft max

RED — RED
PURPLE — PURPLE
YELLOW — YELLOW
GREY — GREY

NOTE:
Make certain to maintain consistent wire color across the transfer to maintain polarity.

Function Statement:

- From exterior - locked condition:** Access by presenting card to unlock active leaf.
- From exterior - unlocked condition:** Doors to remain locked unless held unlocked by access system or momentarily unlocked by push button.
- From interior - locked condition:** Free egress at all times by means of exit device.
- From interior - unlocked condition:** Free egress at all times by means of exit device.
- General:** This is a basic and generic diagram. For a project specific wiring diagram, please contact your Kawneer representative.

Title: Paneline EL Exit Device 2 Pair 1 Active SP-1000X.vsd		Project:	
Heading:		Door:	
Date: 3/19/2014	Date Printed: 3/19/2014	Last Revised: 3/19/2014	10:44:32 AM
Drawn By: Cody Richardson	For: Kawneer Company, Inc.	SO: SPG SO	1 OF 1



Special Projects Group
(888) 284-4774

NOTES:

- 1) Verify that each component requiring or supplying power has been configured for proper system voltage before applying power.
- 2) All wires to be 18 awg 100' max unless otherwise noted on drawing. Refer to manufacturers instructions for proper wire gauge on any power supply, electric device or electrified lock hardware. Manufacturers requirements take precedence.
- 3) All line voltage power to be I/A/W local electrical code.
- 4) All low voltage wires to be stranded copper unless superseded by local electrical code or electric device manufacturer.

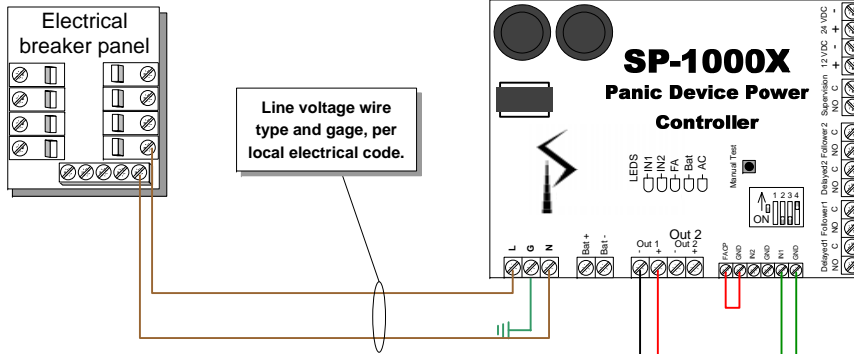

14 AWG - 40ft max
12 AWG - 60ft max
10 AWG - 100ft max

POWER TRANSFERS

NOTE:

Optional power transfers are available. Please note variations in wire size and maximum run length for these options.

- 14 AWG - 35 ft max
- 12 AWG - 55 ft max
- 10 AWG - 95 ft max

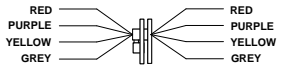
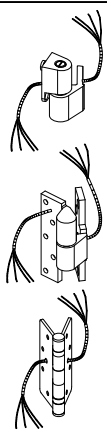

NOTE:
Make certain to maintain consistent wire color across the transfer to maintain polarity.

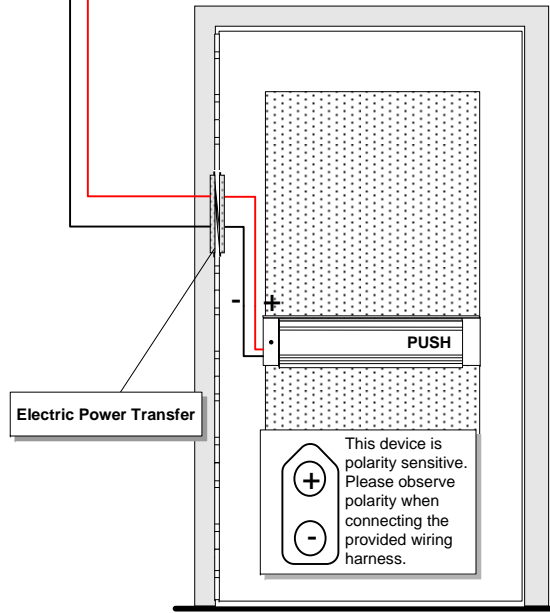
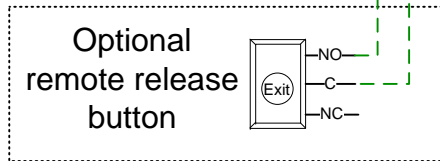

Interior

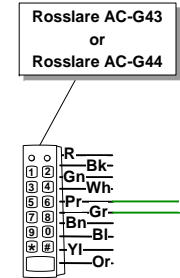

Exterior

These drawings are the sole and exclusive property of Special Projects Group and contain sensitive privileged or confidential information which may be used only for its benefit. The disclosure of these drawings to unauthorized persons is strictly prohibited. This document and all copies must be returned upon demand. COPYRIGHT © 2014. SPECIAL PROJECTS GROUP, INC.

FOR REFERENCE ONLY

This drawing is not a substitute for qualified field technicians. One hour of telephone support is available without charge.

Function Statement:

- From exterior - locked condition:** Access by means of presenting valid credential or entering valid code.
- From exterior - unlocked condition:** Door to remain locked unless toggled unlocked by valid toggle code.
- From interior - locked condition:** Free egress at all times by means of exit device.
- From interior - unlocked condition:** Free egress at all times by means of exit device.
- General :** Diagram for use with "stand alone" Rosslare AC-G43 key pad or AC-G44 key pad / proximity card reader.

Title: Paneline EL Exit with Rosslare SP-1000X.vsd		Project: Paneline EL with Rosslare Key Pad	
Heading: Paneline EL		Door: Kawneer Paneline	
Date: 3/19/2014	Date Printed: 3/19/2014	Last Revised: 3/19/2014	10:47:02 AM
Drawn By: CMR	For: Kawneer Company, Inc.	SO: N/A	Pg: 1 OF 1